

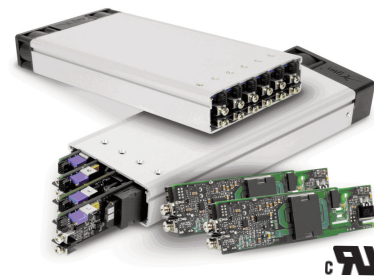

## *UltiMod*

*The UltiMod series from Excelsys - the Ultimate range of Modular Configurable Power Supplies*

- *Unique in Flexibility*
- *Unrivalled in Performance*
- *Ultra Cost Competitive*



**Unique in Flexibility, Unrivalled in Performance, Ultra Cost Competitive**

**FEATURES & OPTIONS**

- Dual Safety Approvals
  - UL/EN60950 2nd edition
  - UL/EN60601-1 3rd edition
- Highest Efficiency - up to 92%
- User & Field Configurable
- Standard Medical Features
  - Leakage Current <300µA (<150µA optional)
  - 2 MOPP
  - 4KV Isolation
- Lowest Acoustic Noise
- -40°C Startup Temperature
- Extra Ruggedised as Standard
  - Shock: >60G's
  - Vibration: MIL STD-810G
- No Minimum Load
- Extra low profile <1U height
- All outputs fully floating
- Series / Parallel of multiple outputs
- 5V Isolated standby voltage
- Product Options: Conformal Coating, Low Leakage Current, Connector, Cabling & Mounting options and Reverse Fans

**TYPICAL APPLICATIONS**

- Medical; Clinical diagnostic equipment, Medical lasers, Dialysis equipment, Radiological Imaging, Clinical Chemistry
- Industrial; Test and Measurement, Industrial Machines, Automation equipment, Printing, Telecommunications, Audio equipment

The UltiMod Series from Excelsys - the **Ultimate** range of Modular Configurable Power Supplies provides up to 1200W output power in a compact 1U form factor. The series is designed for **highest efficiencies** and consists of two Input AC front ends (*powerPacs*), UX4 and UX6 and 11 DC output *powerMods* (XgA to XgL).

Both *powerPacs* carry **dual safety certification**, EN60950 for Industrial Applications and EN60601-1 3rd Edition for Medical Applications. The UX4 delivers up to 600W and can be populated with up to 4 *powerMods*, the UX6 delivers up to 1200W and can be populated with up to 6 *powerMods*.

The *powerMods* provide up to 12 fully isolated DC outputs ranging from 1.0V to 58V. Users can select the modules most suitable for their application based on power level and/or desired control feature set. The series provides **unique levels of flexibility** and is completely user field configurable. Customers can configure any combination of *powerMods* in series/parallel. This unique flexibility combined with our Industry leading **5 Year Warranty** minimises the total cost of ownership for our customers.

**The UltiMod Series of modular configurable power supplies provides global leadership in product reliability, efficiency and cost effectiveness.**



**UltiMod powerPacs**

	Model	Slots	Power	Medical Approval UL/EN60601-1 3rd edition	Industrial Approval UL/EN60950 2nd edition
UX	UX4	4	600W	Yes	Yes
	UX6	6	1200W	Yes	Yes

**UltiMod powerMods**

Model	Vnom (V)	Set Point Adjust Range (V)	Dynamic Vtrim Range (V)	I <sub>max</sub> (A)	Power (W)	Remote Sense	Power Good
XgA	12.0	10.8-15.6	-	12.5	150	-	-
XgB	24.0	19.2-26.4	-	8.3	200	-	-
XgC	36.0	28.8-39.6	-	5.6	200	-	-
XgD	48.0	38.5-50.4	-	4.2	200	-	-
XgE	24.0	5.0-28.0	-	5.0	120	-	Yes
XgF	24.0	5.0-28.0	-	3.0	72	-	Yes
	24.0	5.0-28.0	-	3.0	72	-	Yes
XgG	2.5	1.5-3.6	1.0-3.6	40.0	100	Yes	Yes
XgH	5.0	3.2-6.0	1.5-6.0	36.0	180	Yes	Yes
XgJ	12.0	6.0-15.0	4.0-15.0	18.3	220	Yes	Yes
XgK	24.0	12.0-30.0	8.0-30.0	9.2	220	Yes	Yes
XgL	28.0	24.0-58.0	8.0-58.0	5.0	240	Yes	Yes

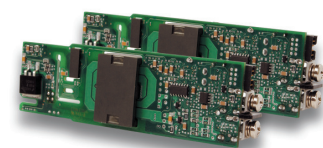

INPUT					
Parameter	Conditions/Description	Min	Nom	Max	Units
<b>Input Voltage Range</b>	Universal Input 47-440Hz	85 120		264 380	VAC VDC
<b>Power Rating</b>	UX4: See derating curves page 4 UX6: See derating curves page 4		600 1200		W W
<b>Input Current</b> UX4 UX6	85VAC in 400W out 85VAC in 850W out		7.5 11.5		A
<b>Inrush Current</b>	230VAC @ 25°C			25	A
<b>Undervoltage Lockout</b>	Shutdown	65		74	VAC
<b>Fusing</b> UX4 UX6	250V 250V		F8A HRC F12A HRC		
OUTPUT					
Parameter	Conditions/Description	Min	Nom	Max	Units
<b>powerMod Power</b>	As per powerMod table				
<b>Output Adjustment Range</b>	Manual: Multi-turn potentiometer. As per powerMod table Dynamic: As per powerMod table				
<b>Minimum Load</b>			0		A
<b>Load &amp; Cross Regulation</b>	For 25% to 75% load change			±0.2	%
<b>Transient Response</b>	For 25% to 75% load change: Voltage Deviation; XgA-XgD Settling Time: XgA-XgD Voltage Deviation: XgE-XgL Settling Time: XgE-XgL			2.5 500 10 250	% µs % µs
<b>Ripple and Noise</b>	20MHz 100mV or 1.0% pk-pk (except 150mV XgA)				
<b>Overvoltage Protection</b>	Latching	110	120	150	%
<b>Overcurrent Protection</b>	Straight line with hiccup activation at <30% of Vnom.	110	133	160	%
<b>Line Regulation</b>	For ±10% change from nominal line			±0.1	%
<b>Remote Sense</b>	Max. line drop compensation (except XgA, B, C, D, E, F)			0.5	VDC
<b>Overshoot</b>				2	%
<b>Rise Time</b>	Monotonic		15		ms
<b>Turn-on Delay</b>	From AC in and Global Enable powerMod Enable		300 2		ms ms
<b>Hold-up Time</b>	For nominal output voltages at full load.	15		20	ms
<b>Output Isolation</b>	Output to Output/Output to Chassis	500 / 500			VDC
GENERAL					
Parameter	Conditions/Description	Min	Nom	Max	Units
<b>Isolation Voltage</b>	Input to Output Input to Chassis	4000 1500			VAC VAC
<b>Efficiency</b>	230VAC, 1200W @ 24V		90	92	%
<b>Safety Agency Approvals</b>	EN60601-1 3rd Edition, UL60601-1, CSA601, UL File No. E230761 EN60950 2nd Edition, CSA C22.2 No. 60950-1, UL File No. E181875				
<b>Leakage Current</b>	250VAC, 60Hz, 25°C 250VAC, 60Hz, 25°C (Option 04)			300 150	µA µA
<b>Signals</b>	See Page 4				
<b>Bias Supply</b>	Always on, current 500mA	4.8	5.0	5.2	VDC
<b>MTBF</b>	UX4 with two XgA's @ full load. Telecordia SR-332, Issue 1 May 2001, ground benign, ambient temperature of 40°C	670			kHours
EMC					
Parameter	Standard	Level			Units
<b>Emissions</b>					
<b>Conducted</b>	EN55011, EN55022, FCC		Level B		
<b>Radiated</b>	EN55011, EN55022, FCC		Level B		
<b>Harmonic Distortion</b>	EN61000-3-2 Class A		Compliant		
<b>Flicker &amp; Fluctuation</b>	EN61000-3-3		Compliant		
<b>Immunity</b>					
<b>Electrostatic Discharge</b>	EN61000-4-2		Level 2		
<b>Radiated Immunity</b>	EN61000-4-3		Level 3		
<b>Fast Transients-Burst</b>	EN61000-4-4		Level 3		
<b>Input Line Surges</b>	EN61000-4-5		Level 3		
<b>Conducted Immunity</b>	EN61000-4-6		Level 3		
<b>Voltage Dips</b>	EN61000-4-11		Compliant		
ENVIRONMENTAL					
Parameter	Conditions/Description	Min	Nom	Max	Units
<b>Operating Temperature</b>	Operates to specification below -20°C after 10 min warm-up	-40		+70	°C
<b>Storage Temperature</b>		-40		+85	°C
<b>Derating</b>	See Page 4 for full temperature deratings				
<b>Relative Humidity</b>	Non-condensing	5		95	%RH
<b>Shock</b>		60			G
<b>Vibration</b>	MIL-STD810G				Hz
<b>Altitude</b>	Up to 3000m (10000ft)				

**Output Connectors**

The output *powerMods* connection details are shown below. Type A connectors are for single output *powerMods* XgA to XgL. The Type B connector is for the Dual output XgF *powerMod*. The power and signal connectors are as follows:

**Type A: *powerMods* XgA to XgE XgG to XgL**

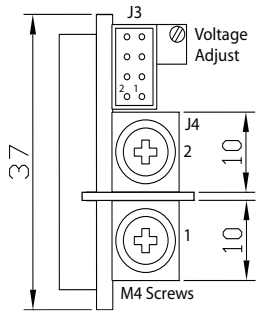

**Type B: *powerMod* XgF**

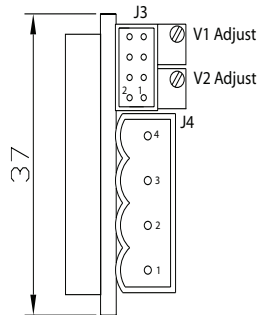

**Output Signals and Power Connector Pinout**

Pin	J3	J3	J3	J3	J4	J4
Module	(XgA to XgD)	(XgG to XgL)	(XgE)	(XgF)	(Type A)	(Type B)
1	not used	+Sense	not used	-pg (V2)	-Vout	-V2
2	Common	-Sense	not used	+pg (V2)	+Vout	+V2
3	not used	Vtrim	not used	Inhibit (V2)		-V1
4	not used	Itrim	Common	Common (V2)		+V1
5	+Inhibit	+Inhibit/Enable	-pg	-pg (V1)		
6	-Inhibit	-Inhibit/Enable	+pg	+pg (V1)		
7	not used	+pg	Inhibit	Inhibit (V1)		
8	not used	-pg	Common	Common (V1)		

**Output Mating Connectors**

J3: Locking Molex 51110-0860; Non Locking Molex 51110-0850; Crimp Terminal: Molex p/n 50394.

J4: M4 Screw

**Series Connection**

To achieve increased output voltages, simply series outputs using standard series links, paying attention to the requirements to maintain SELV levels if required in your system.

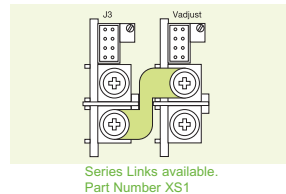

**Parallel Connection for *powerMods* XgA to XgL**

To achieve increased current capacity, simply parallel outputs using the standard parallel links. Excelsys 'wireless' sharing ensures that current hogging is not possible. To parallel connect outputs:

1. Switch on IShare switch to ON for *powerMods* XgG - XgL or add jumper to current share header LK1 for *powerMods* XgA-XgD.
2. Connect Negative Parallel Link.
3. Adjust output voltages of *powerMods* to within 5mV of each other.
4. Connect Positive Parallel Link.

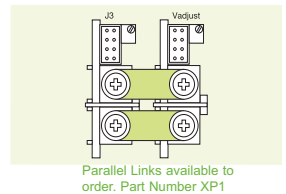

**DIP Switch for Current Share & Inhibit/Enable for *powerMods* XgG to XgL**



Dip Switch settings above are:

Current Share: OFF

Inhibit ON: Normally ON

**LK1 for Current Share on *powerMods* XgA to XgD**

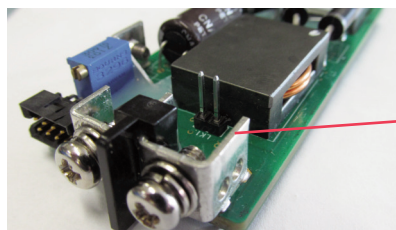

LK1 (Attach jumper here)

Recommended Jumper for LK1: HARWIN M7567-05 (Jumper Socket, Black, 2.54mm, 2-way)

**DIP Switch Option for XgG to XgL**

*powerMods* can be configured to be normally ON or normally OFF by appropriate setting of the DIP switch on the *powerMod*. (default mode is normally ON). The *powerMod* will deliver output voltage when mains is applied (and the *powerPac* is enabled). The *powerMod* requires an external 5V signal (between +IN/EN and -IN/EN) to disable the output pins. This may be reversed by setting of the dip switch to the OFF position.

**Input Connectors**

The UltiMod series has a variety of input connector options to ease system integration. These include IEC, Input cables (3-wire) and IEC to Screw Terminal Adaptor.

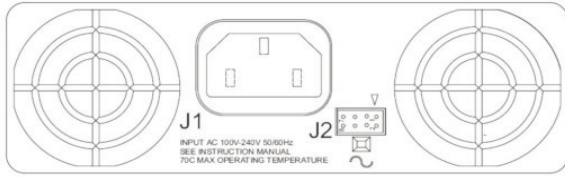

Pin	J1	J2
1	Line	Common
2	Neutral	+5V Bias
3	Earth	not used
4		AC Fail
5		Fan Fail
6		Global Enable
7		Temp Alarm
8		Global Inhibit

**Input Mating Connectors**

J1: IEC320 type female plug rated 13, Locking IEC cable and connector: Schaffner EMC part number IL13-US1-SVT-3100-183.

J2: Locking Molex 51110-0850; Non Locking 51110-0860; Crimp Terminal: Molex p/n 50394

**Input Cable (Option D)**

The UltiMod Series is also available with an input cable connection option allowing greater flexibility when mounting the UltiMod in the system. Input cables are 300mm in length and come supplied with Faston connectors.

**IEC to Screw Terminal Adaptor**

Some applications may require a screw terminal input rather than the standard IEC320 connector provided with the UltiMod. For such applications, Excelsys can offer the XE1, the IEC to Screw terminal adaptor accessory plug. This is a press fit connector that plugs securely into the UltiMod *powerPac* and provides the system integrator with screw terminals for mains connection.

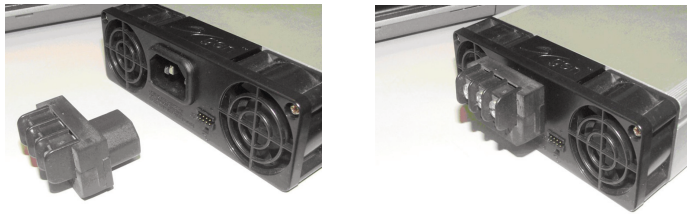

**UltiMod Mounting Options**

To ease system integration there are three methods of mounting the UltiMod in a system.

**1. Base Plate Mounting**

The unit can be mounted in the system via the mounting holes present on the base. See mechanical drawings for mounting hole positions. Use M4 mounting screws. Ensure that maximum screw penetration from base does not exceed 6mm.

**2. Fleximount - side mounting clip**

Using the side mounting clips accessory shown. The clip can be positioned at the user defined position along the slide rail on the side of the UltiMod. The clip is then mounted to the system base plate. Use M4 mounting screws to fix mounting clip to system base. Excelsys part number Z165.



**3. Fleximount - self clenching studs**

Using the slide rail on side of the UltiMod, self clenching studs can be placed at a user defined position. Recommend: PEM FH-M4-X or FH-832-X or equivalent.

**Derating Curves**

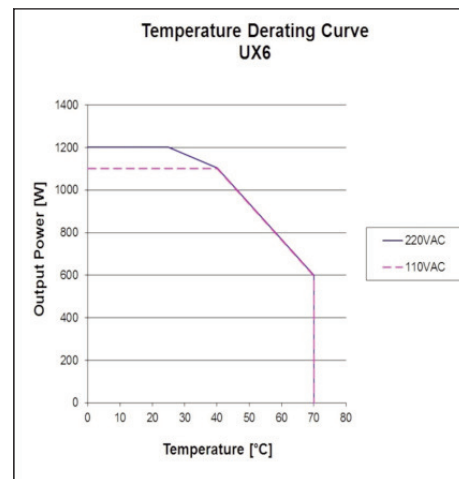
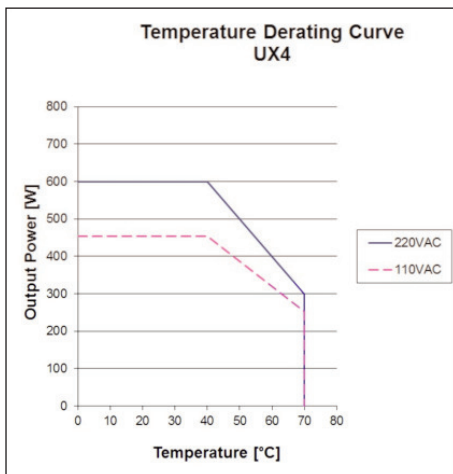

**Mechanical Drawings**

**UX4: 4 Slot UltiMod powerpac**

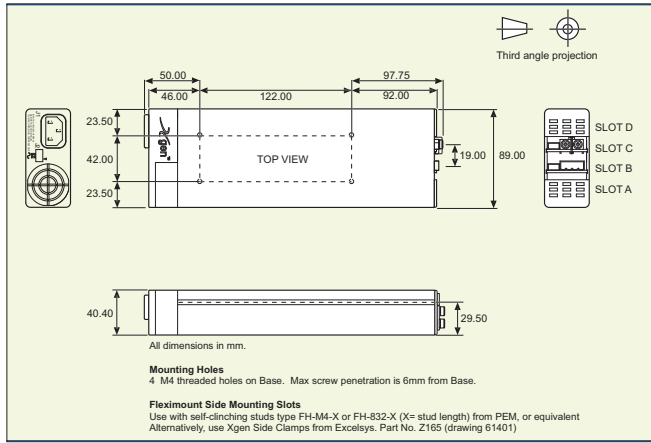

**UX6: 6 Slot UltiMod powerpac**

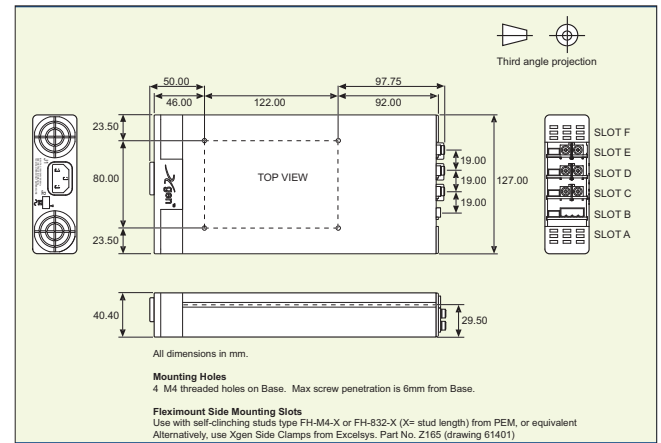

**Configuring your UltiMod**

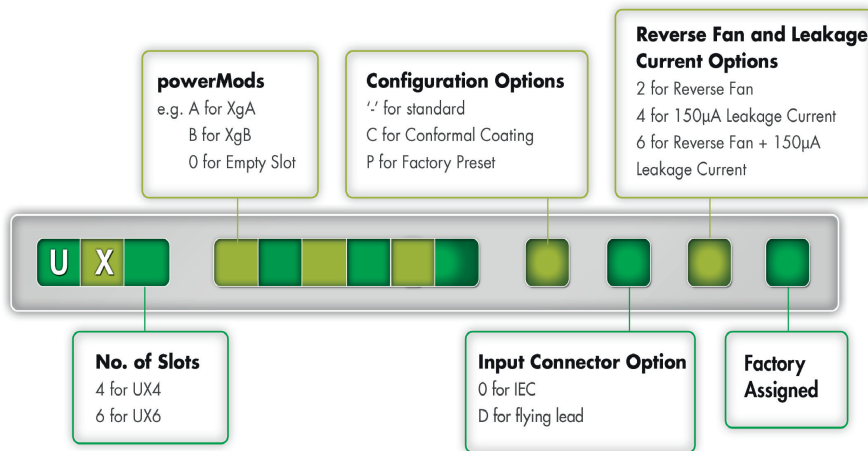

**Configuration Example 1: UX4CGD0-D4 contains;**

UX4 powerPac: 600W 4-slot chassis, Standard module settings:

Slot 1: XgC: 36V/5.6A

Slot 2: XgG: 2.5V/40A

Slot 3: XgD: 48V/4.2A

Slot 4: Empty

Option D: Input cable option; Option 4: 150µA leakage current option.

**Configuration Example 2: UX4CGD0PD4B contains;**

UX4 powerPac: 600W 4-slot chassis, Factory preset module settings:

Slot 1: XgC: 32V/5.6A XgC output voltage factory adjusted to 32V

Slot 2: XgG: 2.5V/40A

Slot 3: XgD: 46V/4.2A XgD output voltage factory adjusted to 46V

Slot 4: Empty

Option D: Input cable option; Option 4: 150µA leakage current option; B: Factory assigned unique identifier.

**Configuration Example 3: UX6BBDDA0C02A contains;**

UX6 powerPac: 1200W 6-slot chassis, Factory preset module settings:

Slot 1: XgB: 24V/8.3A (set in parallel with Slot 2)

Slot 2: XgB: 24V/8.3A (set in parallel with Slot 1)

Slot 3: XgD: 46V/4.2A XgD output voltage factory adjusted to 46V

Slot 4: XgD: 48V/4.2A

Slot 5: XgA: 12V/12.5A

Slot 6: Empty

Option C: Conformal Coated; Option 2: Reverse Fan; B: Factory assigned unique identifier.

**Configure your UltiMod using our Online Configurator**

Our Sales and Applications teams will be delighted to assist you in defining the best power supply for your application. You can also use our online configurator available at [http://www.excelsys.com/xgen\\_configurator/configure.html](http://www.excelsys.com/xgen_configurator/configure.html).